

Transit Products



B BUNTING GRAPHICS

Bunting Graphics, Inc.
20 River Road
Verona, PA 15147
Tel: 412.820.2200
Fax: 412.820.4404
www.buntinggraphics.com

Bus Stop Signs and Flags

Overview

Bunting Graphics is an architectural fabricator with an important niche in the transit industry supplying signage, kiosks, transit stop shelters and furnishings. The company's expertise in stainless steel signage results in signage and shelter products that are modern, attractive and easy to maintain.

Standard products include:

- Schedule holders
- Bus stop signage
- Transit Kiosks
- Digital Messaging
- Directories
- Shelters
- Station Signage

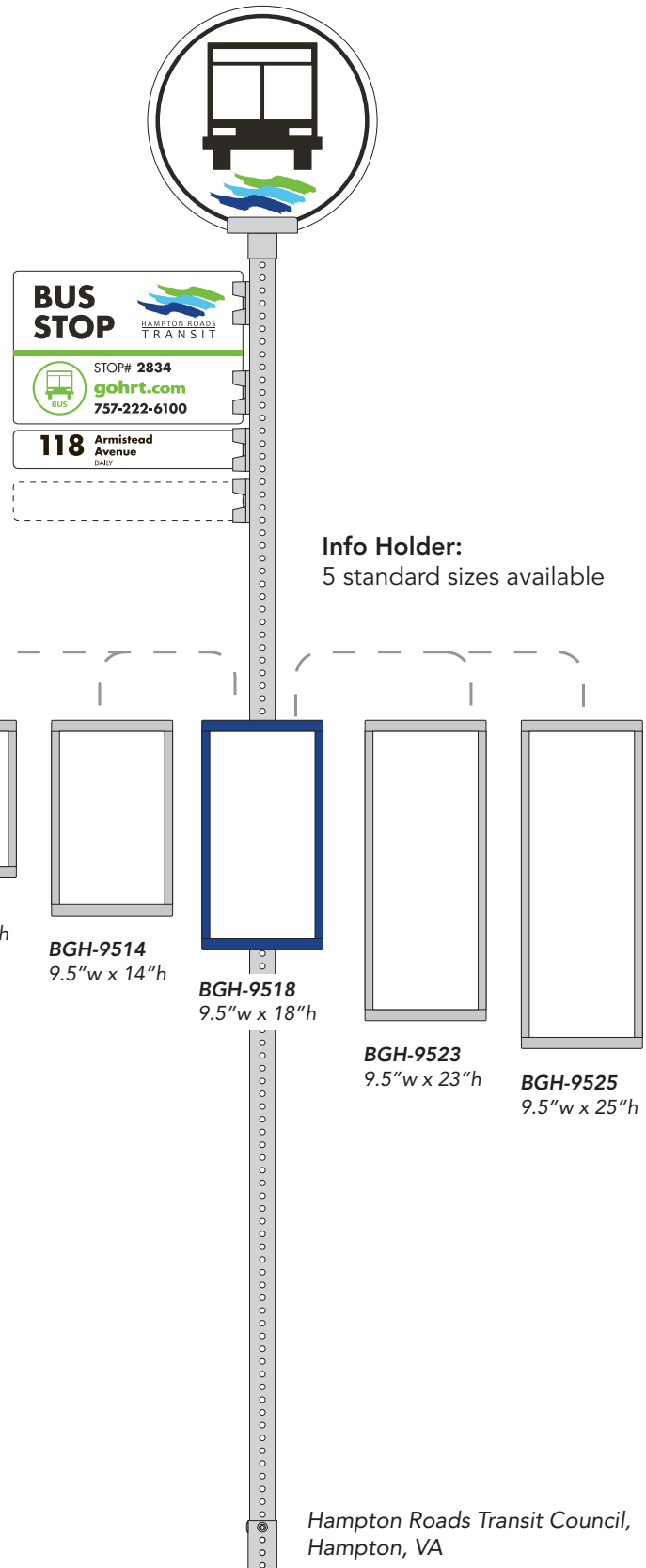

Bus Stop Signs and Flags



Flag Options

Bunting Graphics' Transportation Information Holders help convey information to customers allowing them to easily navigate from one transit system to another with the greatest ease and convenience.

Features & Benefits

- Signage is attractive and durable with rounded edges for public safety.
- Signage mounts quickly on round, square or U-channel posts with supplied stainless steel hardware that is tamper resistant.
- Durable powder coated finish on mounting pole. Standard and custom colors available.
- Direct embed, break-away or baseplate mounting available.
- 2-3/8" round or 1-3/4" and 2" Unistrut mounting poles.



EuroForm™ Modular Transit Signage System

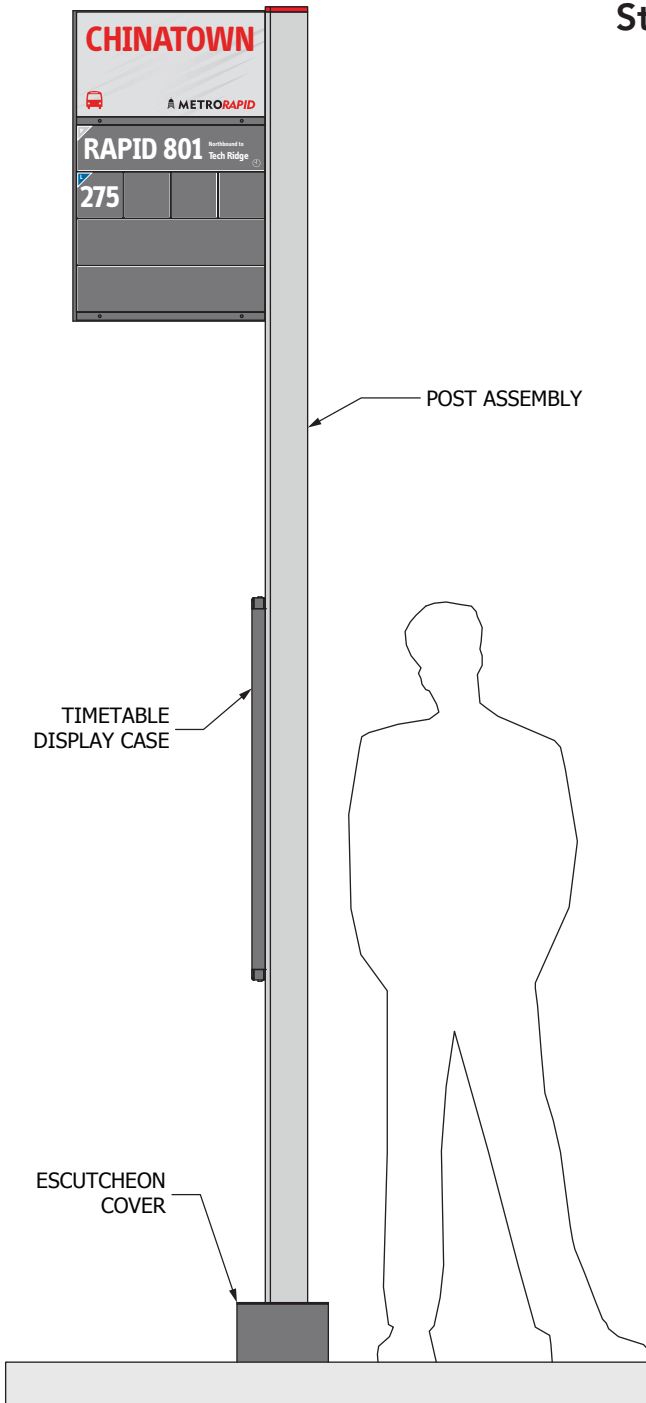

Stylish, functional and completely customizable.

The Euroform bus stop system is a sleek modular sign system designed for the transit industry.

The durable construction grade components can be combined to communicate bus routes and transit services, route maps and branding in one convenient and attractive package.

The aluminum post is iconic and readily observed as a transit stop amid the urban clutter of U-channel posts and signage. The architectural appearance and high quality finishes will enhance any transit brand.

Euroform components include sign mast, modular sign faces that easily attach with tamper-resistant hardware and stainless steel map cases.



Capital Metropolitan Transit Authority, Austin, Texas

Custom Options:

- Custom Paint Finishes
- Solar Power
- Stainless Steel Cases
- Touch screen display

Transit Information Holders

Ease of Use is Built In.

Bunting Graphics' Transportation Information Holders help convey route information to customers allowing them to easily navigate from one transit stop to another with the greatest convenience.

The aluminum holders are attractive and durable, with rounded edges for public safety. The finish is powder coated for maximum durability.

Single sign holders mount to either U-channel or square posts. Multi-sign assemblies mount to either square or round posts. The owner is responsible for ensuring that their selected installation option will meet the local code requirements.

An impact resistant polycarbonate clear lens protects the posted information. A driver/spanner bit is required for opening the case and replacing inserts.

Installation Options

Single Panel



3-Sided

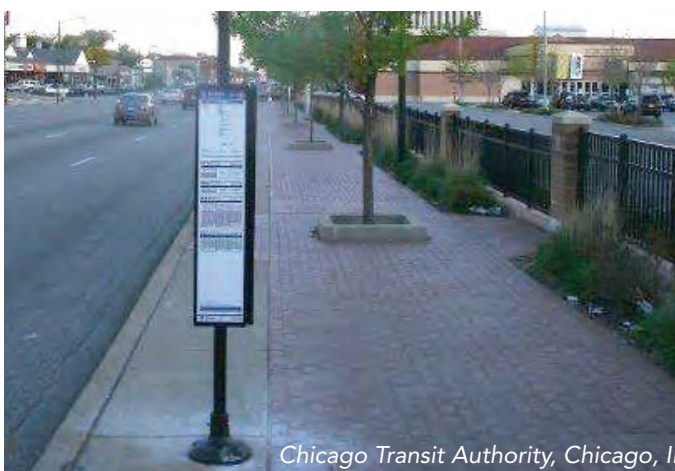

Chicago Transit Authority, Chicago, IL

Transit Information Holders

Product Line

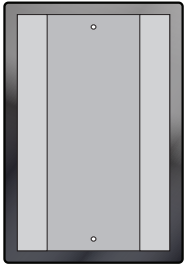

BGH-1117
Visible Opening: 11" x 17"
Overall Size: 13" x 19"

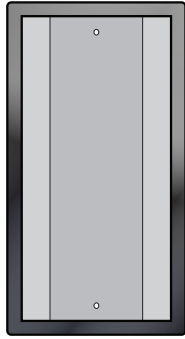

BGH-1122
Visible Opening: 11" x 22"
Overall Size: 13" x 24"



BGH-8511
Visible Opening: 8-1/2" x 11"
Overall Size: 10-1/2" x 13"



BGH-8514
Visible Opening: 8 1/2" x 14"
Overall Size: 10-1/2" x 16"



BGH-8517
Visible Opening: 8-1/2" x 17"
Overall Size: 10-1/2" x 19"

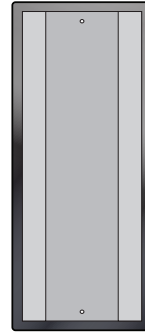

BGH-8522
Visible Opening: 8-1/2" x 22"
Overall Size: 10-1/2" x 24"

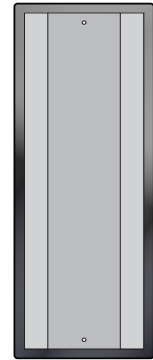

BGH-8524
Visible Opening: 8-1/2" x 24"
Overall Size: 10-1/2" x 26"

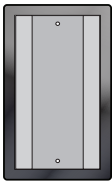

BGH-0611
Visible Opening: 6" x 11"
Overall Size: 8-1/4" x 13"



BGH-0614
Visible Opening: 6" x 14"
Overall Size: 8-1/4" x 16"



BGH-0617
Visible Opening: 6" x 17"
Overall Size: 8-1/4" x 19"



BGH-0622
Visible Opening: 6" x 22"
Overall Size: 8-1/4" x 24"



BGH-0624
Visible Opening: 6" x 24"
Overall Size: 8-1/4" x 26"

Transit Information Holders

Mounting Specs

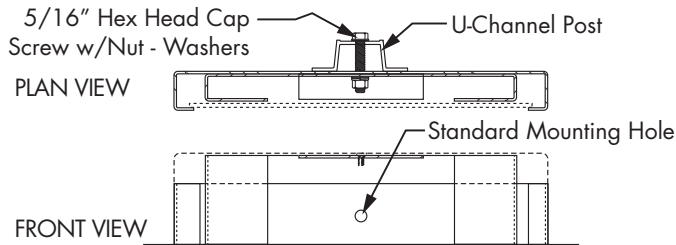

U-CHANNEL INSTALLATION

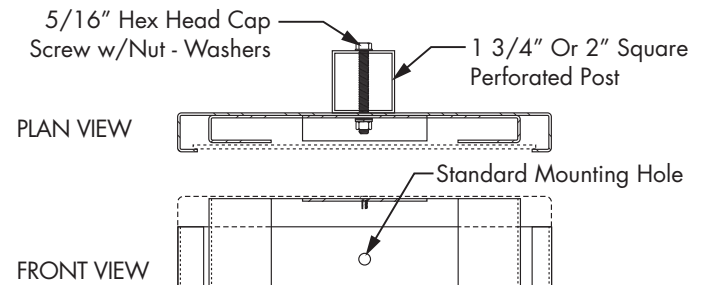

1 3/4" Or 2" SQUARE PERFORATED POST INSTALLATION

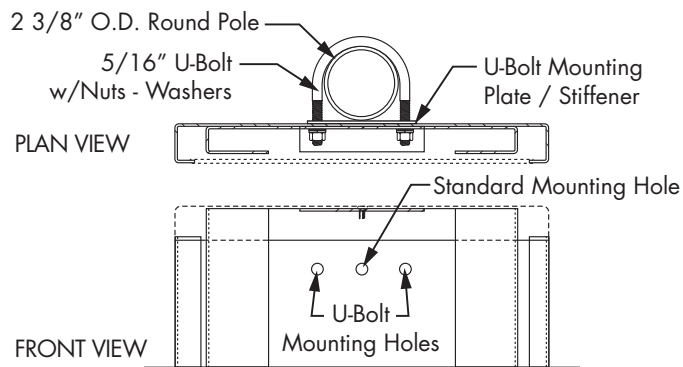

2 3/8" O.D. ROUND POLE INSTALLATION

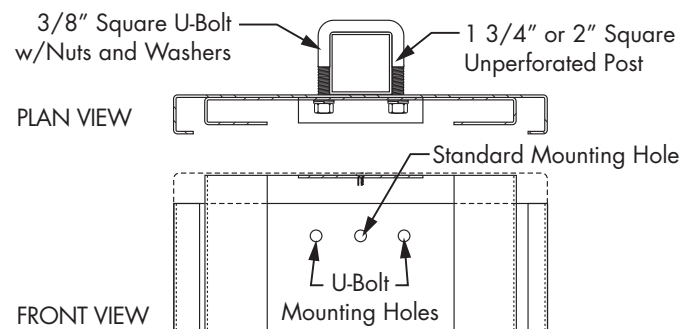

1 3/4" Or 2" SQUARE UNPERFORATED POST INSTALLATION

Kiosks & Directories

Unique Designs

Transit stop kiosks and directories are highly visible means of informing travelers about important mapping and other travel related information such as connections, fares and schedules.

Highly durable and graphically appealing, there are many options available:

- Single Panel
- Double Panel
- 4 sided Kiosks
- LED graphics
- Branding options with graphic and paint application
- Direct embedment, baseplate or break-away mounting



Stainless Steel Directories

Many urban transit stations require directories and information stations that are fabricated from ultra-durable stainless steel.

Bunting Graphics is an expert stainless steel fabricator capable of producing the highest quality product that is attractive and durable.



Options

- Single cabinet or multi-cabinet
- Baseplate mount or wall mount
- Single or double sided
- Custom sized openings to fit client specific information
- Highly tamper proof and durable
- Polycarbonate clear lens resists yellowing and vandalism

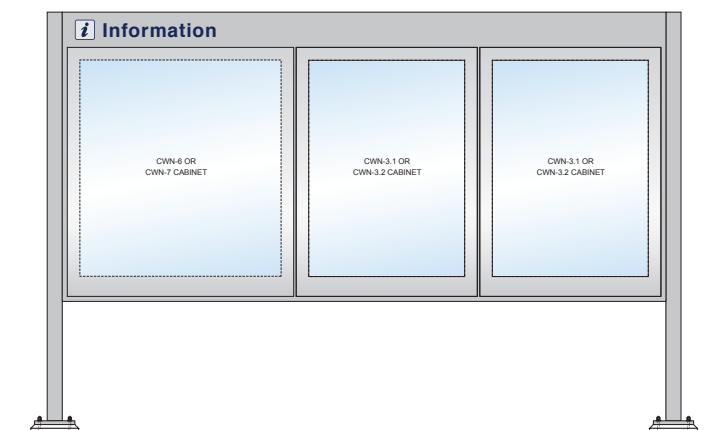

Kiosks & Directories

Green Tech

Solar power can be incorporated into transit stop products.

Examples of solar power illumination include:

- 30 second map illumination at the push of a button
- Dusk to Dawn illumination of header panel
- Custom applications available



Kiosks & Directories



Quality Construction

Greater Richmond Transit Council (GRTC) incorporated 15 of Bunting's bus stop information kiosks to address complaints from the system's 28,000 daily riders that bus arrival times and routes are often a mystery. The design was adopted in part due to the fact that it withstood the impact of a baseball bat swung at full force! GRTC incorporated route information, maps and digital readouts.

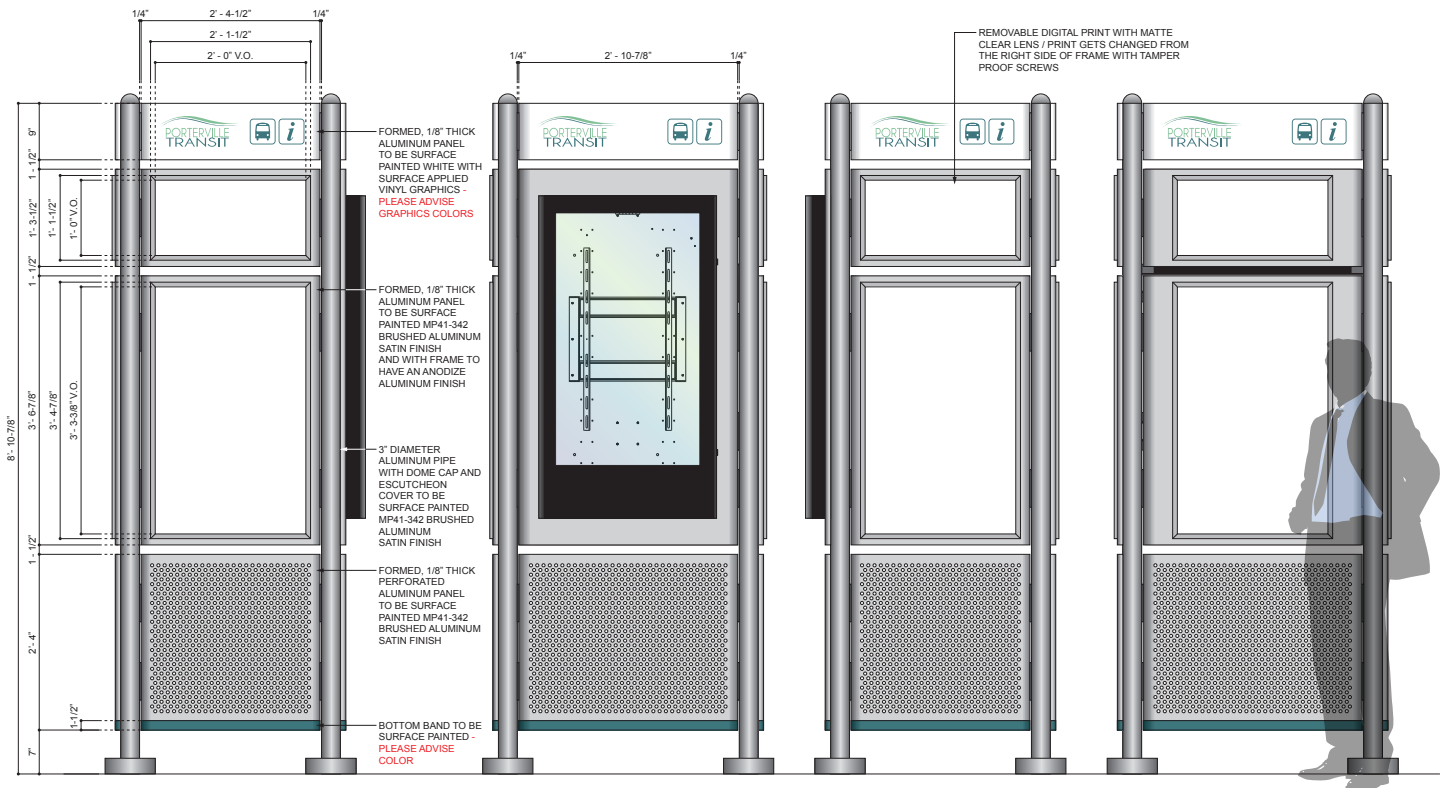

Station Signs

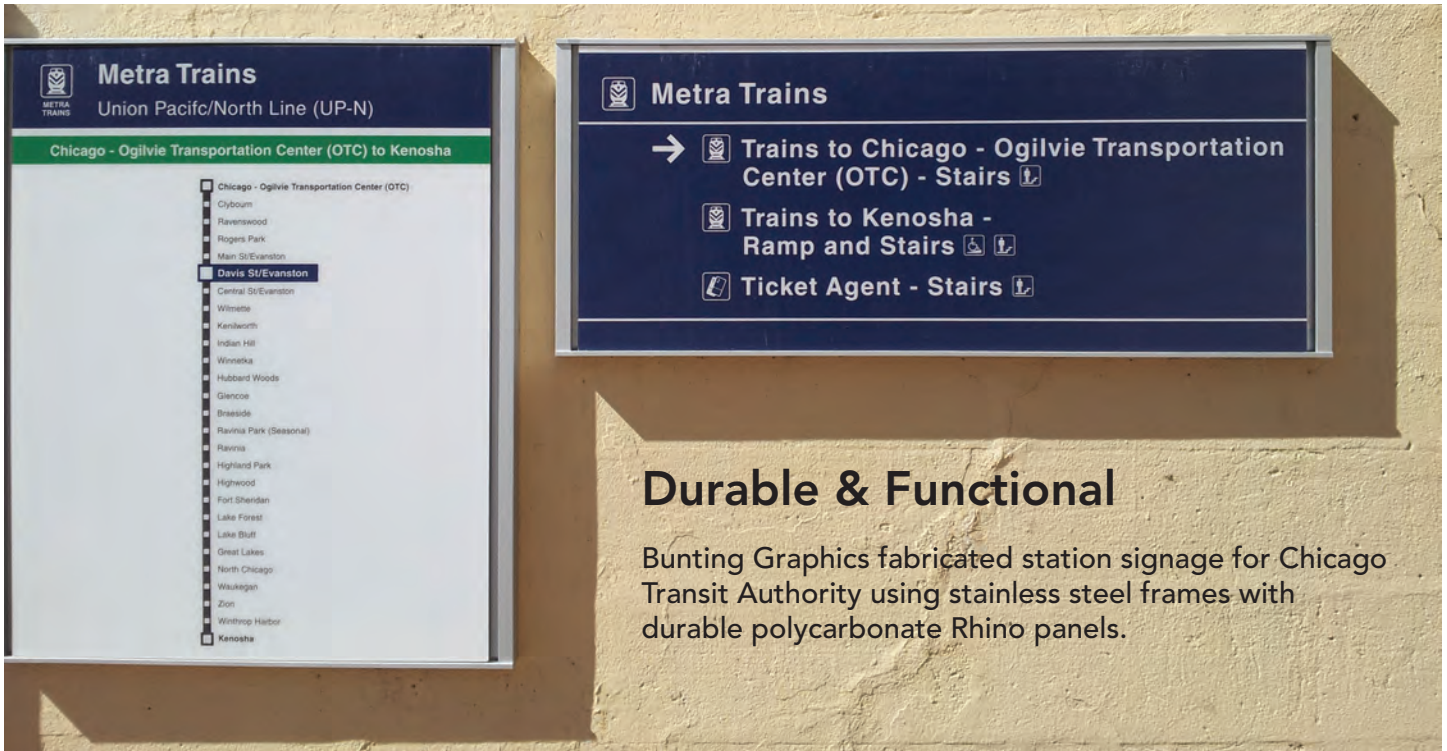

Durable & Functional

Bunting Graphics fabricated station signage for Chicago Transit Authority using stainless steel frames with durable polycarbonate Rhino panels.

Station Sign products include:

- ADA Compliant Signage
- Branding
- Electronic Displays
- Exit Identification Code and Safety Signage
- Information flags
- Logos
- Real-Time Displays
- Wayfinding & Station Signage

